

VITOSOL

Solar heating system
Flat collectors and tube collectors

VIESMANN

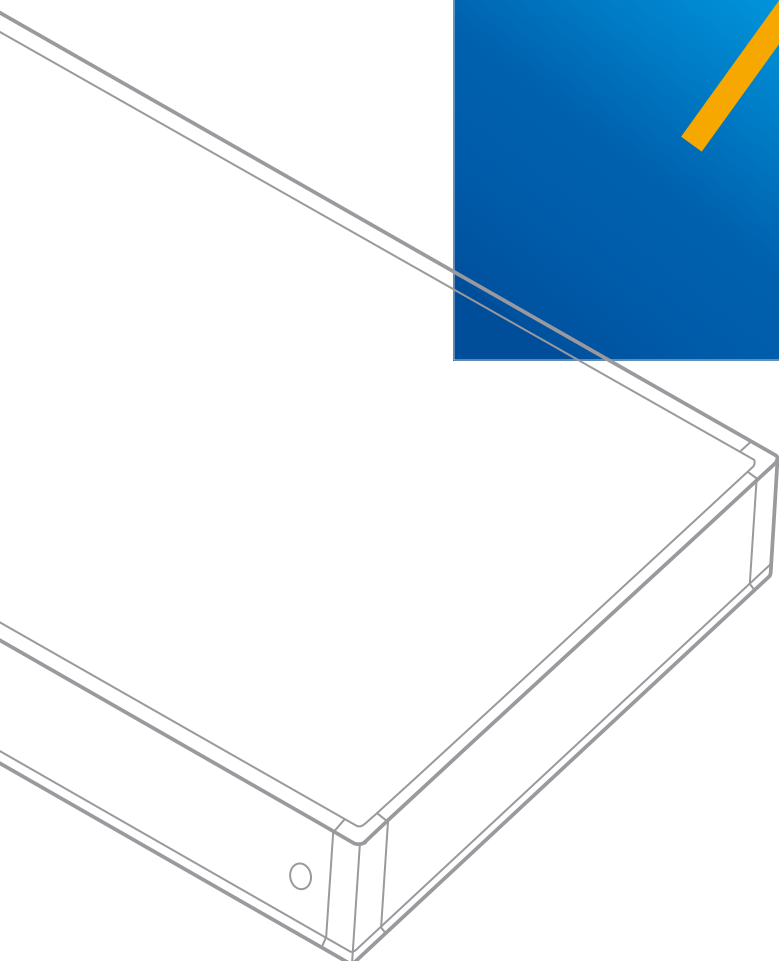

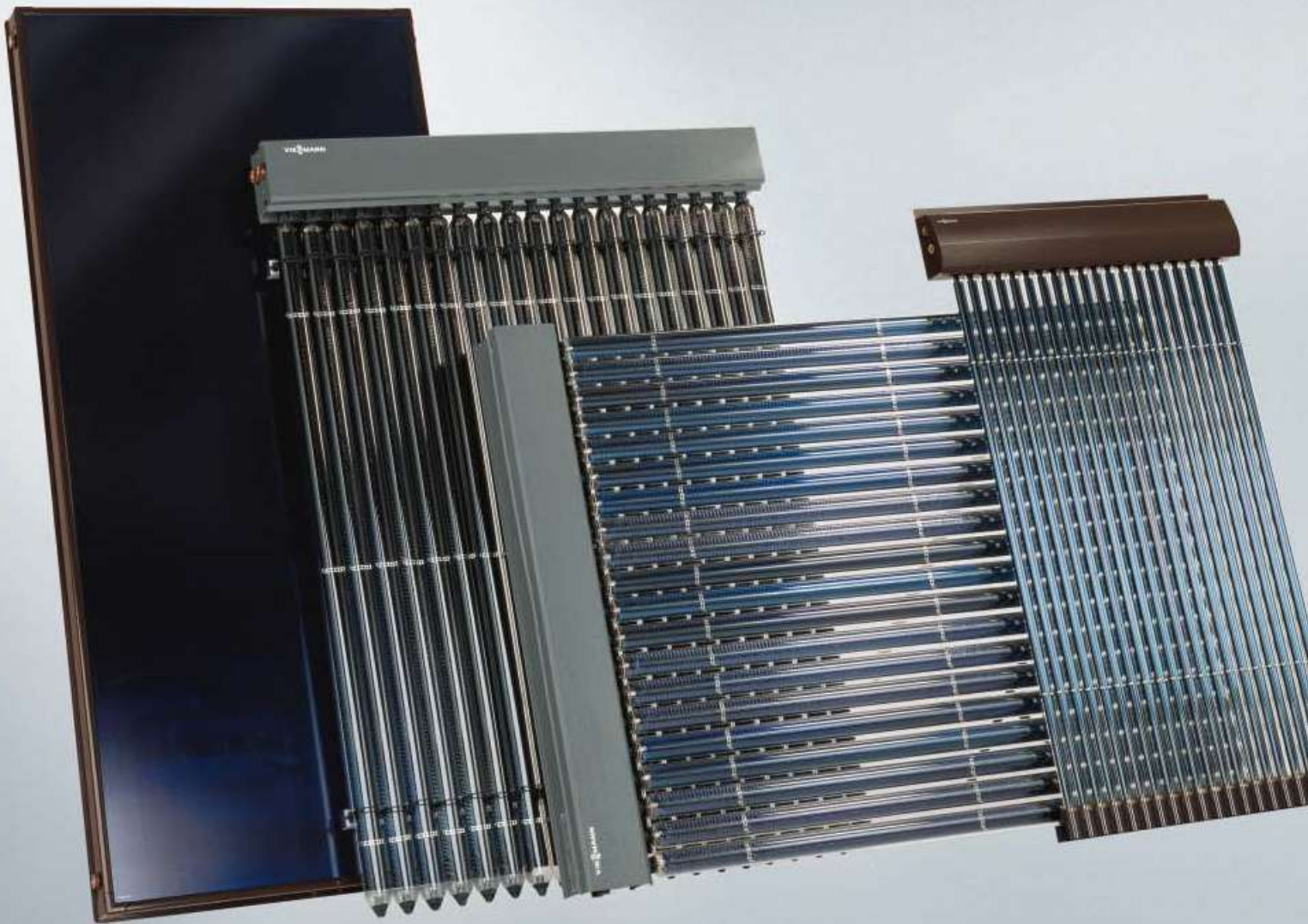

Free energy from the sun

Solar energy doesn't cost you a thing – and it even works in our latitudes. All you need is a solar heating system with highly efficient collectors and matching system components, like Viessmann solar heating systems. Such systems can save 50 to 60% of the annual energy requirement for DHW heating in detached and two-family homes. During the summer months, from May until August, the solar energy is sufficient to cover almost all of the DHW requirement. In the transitional months, solar energy can best be utilised to preheat the DHW, which can significantly reduce oil or gas consumption.

For the environment

The future for the environment is looking brighter, too, because 3/4 tonnes less carbon dioxide (CO₂) per detached house is produced each year using this system. As all Viessmann solar collectors meet the requirements of the "Blue Angel" certificate of environmental excellence, according to RAL UZ 73, things look better still. High operational reliability and a long service life are of equal importance, and Vitosol collectors achieve this thanks to corrosion resistant materials, such as aluminium, copper and stainless steel. The results of the quality test at the SPF Institute in Rapperswil, Switzerland confirm the thermal output of Viessmann solar collectors remains high, over a period exceeding 20 years.

Technology which pays for itself

Those investing in energy-saving and environmentally responsible heating technology, frequently receive support from local or central governments, as well as their energy suppliers. An extensive number of subsidies are available.

As a rule of thumb – await approval of your application, before making your investment. Apply early, as means are frequently limited!

Your heating contractor can advise you of any schemes currently on offer. Further information (about subsidies in Germany) are available from the internet under www.viessmann.com.

Turn the page if you'd like to know more about Vitosol products.

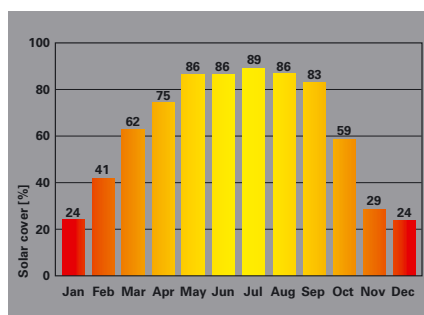

Solar cover for DHW heating in a detached home

Index

VITOSOL 100.....page	4/5
VITOSOL 200.....page	6/7
VITOSOL 250.....page	8/9
VITOSOL 300.....page	10/11
System design.....page	12/13
Sectional views and specification.....page	14/15
Opinions, prognoses...page	16/17
VITOTEC	
Range.....page	18/19



High performance at an attractive price – VITOSOL 100



Vitosol 100 makes a case for itself through low investment costs, as well as through the energy it saves. Its highly selective Sol-Titanium coating now makes solar utilisation yet more effective. Corrosion resistant materials, such as aluminium, copper and stainless steel, plus 4 mm special solar glass, set into an endless gasket, ensure that this effectiveness is maintained over a long service life.

Your time benefit

Vitosol 100 is equally exemplary in terms of its installation: Up to 10 collectors can be swiftly, easily and safely installed on your roof in next to no time - thanks to the Viessmann connection system. To do this, your heating contractor doesn't need to be a roofing expert either.

Tailor-made

Vitosol 100 is offered with 2.5 m² and 4.76 m² absorber surface. For new buildings, roof integration is recommended; for existing buildings, collectors may be mounted on top of the roof or freestanding on flat roofs.

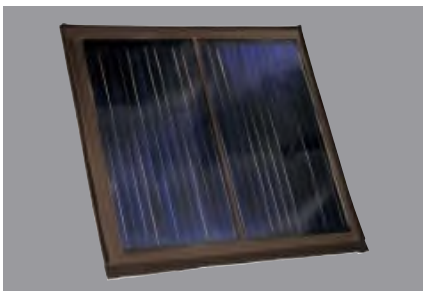

**Vitosol 100 –
large flat collector with 4.76 m²
absorber surface**



Viessmann connection system

New design – new colours

With its individual colours and attractive design, Vitosol 100 offers completely new opportunities to colour-match roof and solar collector. The new edge covers, which are available as accessories for roof integrated panels, ensure a particularly harmonious transition between collector surface and roof. The collector frame and edge cover are supplied in brown, as standard.

On request, the frame and edge covers are supplied in any RAL colours, enabling a perfect match to the colour of your roof, making the solar panel an integral part of your roof design.

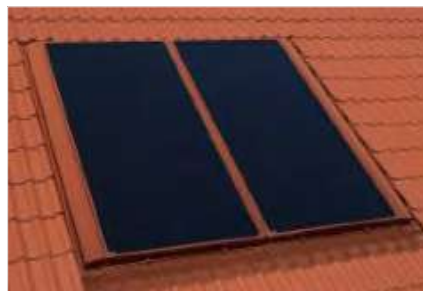

**Frame and edge covers for
Vitosol 100 available in all
RAL colours**

Benefits at a glance:

- Solar flat collector with highly efficient Sol-Titanium coating.
- Gross collector area
Type s/w 2.5: 2.71 m²
Type 5DI: 5.25 m².
- High efficiency through highly selective absorber coating, integral piping and very effective thermal insulation.
- Absorber surface: 2.5 m² for horizontal or vertical installation. Large absorber with 4.76 m² absorber area for roof integration on pitched roofs with tile cover.
- Short installation times through flexible connection pipes. The Viessmann connection system enables up to ten collectors to be easily linked in series.
- Short installation times even for the large collectors (type 5DI) through tiling frame mounted on the collector panel for roof integration, flexible connection pipes and lifting eyes.
- Vitosol 100 can be installed universally: on flat or pitched roofs, on top of roofs, as roof integration or as freestanding installation.
- CE designation and quality test by the SPF Institute, Rapperswil, Switzerland. Meets the requirements of the "Blue Angel" certificate of environmental excellence.



Never turns its back on the sun – VITOSOL 200



Vitosol 200 is a high performance vacuum tube collector, ideally suited to installation in almost any position.

Its direct flow pattern even allows it to be installed lying down on a flat roof or hanging on vertical walls. The individual pipes can be rotated for optimum alignment with the sun.



Vitosol 200 – universal application for pitched or flat roofs or on walls

Energy utilisation right up to the last tube

Thick borosilicate glass and a permanent vacuum sealed glass-metal joint safeguards high operational reliability and a long service life. The solar transfer medium directly flows through the collector tubes. One further advantage is the pre-assembled modular design, ensuring simple handling and short installation times. The proven connection system enables easy hydraulic interconnection.



Flexible double tube connection

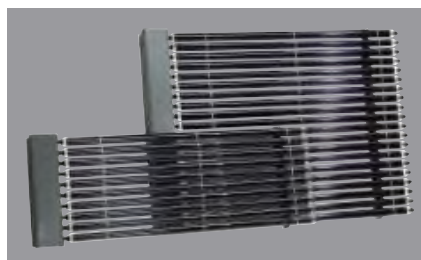

Vitosol 200, type D10 and D20

Benefits at a glance:

- Direct flow vacuum tube collector.
- Gross collector area: 1.50, 2.94 and 4.38 m².
- Absorber area: 1, 2 and 3 m².
- High efficiency through vacuum collector tubes and Sol-Titan absorber coating.
- The direct flow pattern through the collector tubes enables vertical or horizontal installation without support stands.
- Universal application on flat or pitched roofs and walls.
- Individual tubes may be replaced.
- High grade corrosion resistant materials, such as borosilicate glass, copper and stainless steel, safeguard high operational safety and a long service life.
- CE designation and quality test by the SPF Institute, Rapperswil, Switzerland. Meets the requirements of the "Blue Angel" certificate of environmental excellence.



All-glass vacuum tube and absorber – VITOSOL 250



250

The new Vitosol 250 is a direct flow, high performance collector, which is suitable for installation almost anywhere on a building.

The most noteworthy feature of Vitosol 250 is its vacuum tube which is made from glass and holds the vacuum created inside with high reliability – permanently. Individual tubes may be replaced.

Vitosol 250 is supplied as pre-assembled standard unit of 20 tubes.

The proven Viessmann assembly system ensures short installation times.



Vacuum tubes can be replaced individually



Internal mirror effect for higher efficiency and low contamination susceptibility

Benefits at a glance:

- High efficiency, direct flow vacuum tube collector.
- Absorber area: 1.43 m².
- Gross collector area: 1.67 m².
- Glass vacuum tube and coaxial absorber.
- Robust glass joint around the vacuum area.
- Internal mirror effect, for higher efficiency and low contamination susceptibility.
- Optically homogenous surface through slimline tubes.
- Individual tubes can be replaced.
- Flow and return pipes integrated in the header. No additional installation or insulation required.
- Simple installation, thanks to the Viessmann assembly and connection system.
- Special connection elements prevent collector damage through external forces (e.g. wind pressure).
- Universal application on flat or pitched roofs and walls.



The sun shines - even on dull days – **VITOSOL 300**



Vitosol 300 is a high performance vacuum tube collector of the highest standard which operates according to the heat pipe principle. Not only is it suitable for DHW heating, but can also back-up your central heating system.

With the heat pipe system, the solar transfer medium does not directly flow through the tube. A carrier medium, which evaporates with solar influence, circulates through a special absorber, and transfers the heat via a heat exchanger, to the solar medium.

Is there a better way to capture solar energy?

Solar energy is transferred in the highly effective "Duotec" double pipe heat exchanger, which almost completely surrounds the condenser. The transfer is made in a dry state, i.e. without direct contact with the heat carrier medium. The heat exchanger offers high efficiency – even at low solar irradiation. Rotating the collector tubes enables optimum alignment of the tubes to the sun – a further enhancement for solar utilisation.



Highly effective "Duotec" double pipe heat exchanger

Perfect connection

Dry connection of the heat pipes not only simplifies the installation, but also enables the simple replacement of individual tubes in case of breakage. The connection system guarantees the tight joining of several collectors, as well as short installation times, since no other connections or thermal insulation are required.



Vitosol 300

Benefits at a glance:

- Vacuum tube collector according to the heat pipe principle.
- Absorber area: 2 and 3 m².
- Gross collector area: 2.94 and 4.38 m².
- Extremely high efficiency through Sol-Titanium absorber coating; vacuum collector tubes reduce thermal losses.
- Improved thermal utilisation through patented "Duotec" double pipe heat exchanger, which almost completely surrounds the condensers.
- Universal application on flat and pitched roofs as well as freestanding installation. Axial rotation of tubes for optimum alignment with the sun.
- Dry collector tube connection enables the replacement of individual tubes without draining the entire system.
- High grade, corrosion resistant materials, such as borosilicate glass, copper and stainless steel ensure high operational reliability and a long service life.
- Integral temperature limiter to protect panels against overheating.
- CE-designation and quality test by the SPF Institute, Rapperswil, Switzerland. Meets the requirements of the "Blue Angel" certificate of environmental excellence.

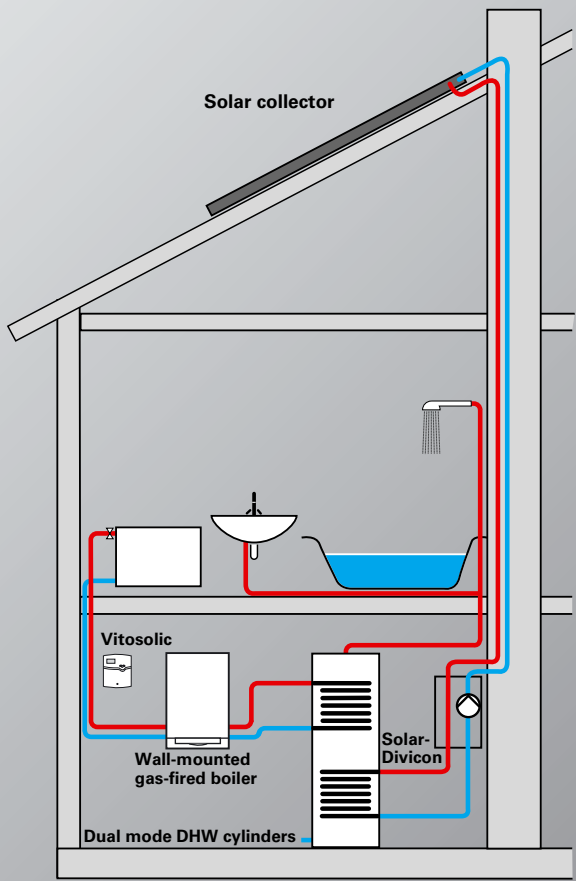

1



2

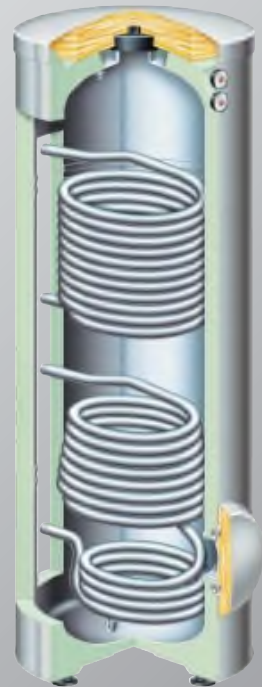

3



5



6



7

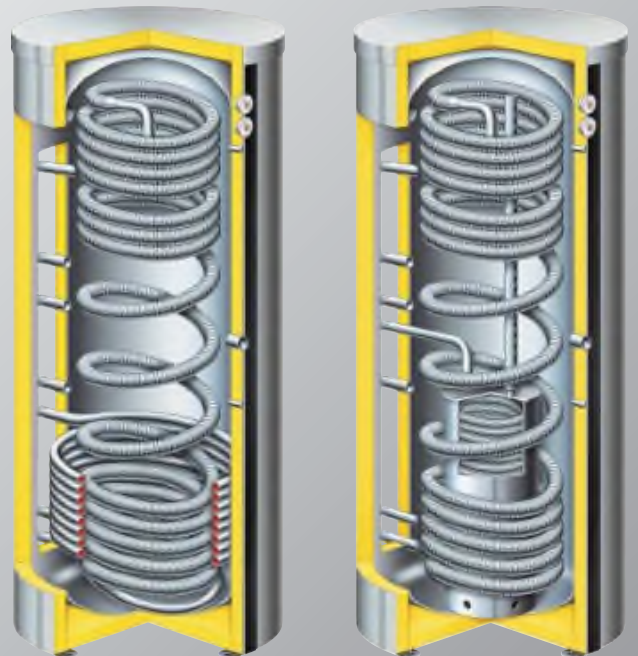

4

Viessmann system design – everything fits together ... perfectly



To achieve optimum effectiveness, Viessmann offers a system design, where everything matches ... perfectly (1).

Vitocell DHW cylinders

Dual mode DHW cylinders, available in silver or white with two indirect coils:

Vitocell-B 100 (2) made from steel with corrosion-resistant Ceraprotect enamel coating (300 and 500 litres capacity) or Vitocell-B 300 (3) made from high-alloy stainless steel (300 and 500 litres capacity).

The heat delivered by the solar panels is transferred to the DHW via the lower coil. Upon demand, backup heat is supplied by a boiler to the upper coil.

Vitocell 333

Vitocell 333 (4, left) is a multi-mode heating water calorifier with integral DHW heating facility.

Total capacity: 750 litres
DHW: 42 litres.

Vitocell 353

Vitocell 333 (4, right) is multi-mode heating water calorifier with stratification loading system and integral DHW heating facility.

Total capacity: 750 litres
DHW: 42 litres.

Vitosolic 100/200 Energy management for solar heating systems

The intelligent Vitosolic energy management system in conjunction with solar panels from the Vitosol range achieve a particularly high level of solar energy utilisation.

Vitosolic 100 and 200 solar control units are designed for solar heating systems with up to four consumers, and cover all common applications. A KM BUS provides data transfer with the weather-compensated Vitotronic control unit.

Vitosolic ensures that the energy yielded on your roof is utilised as effectively as possible for heating DHW or swimming pool water or for central heating backup. Vitosolic 100/200 communicates with the boiler control unit and shuts down the boiler as soon as sufficient solar energy is available. This reduces the boiler load and therefore your heating bills.

Vitosolic 100 product benefits

- Attractively priced electronic temperature differential controller for solar heating systems (5):
- Simple operation in accordance with Vitotronic control principles.

- Two-line display for information about current temperatures and operational conditions of pumps.

- Small housing.

Vitosolic 200 product benefits

- Electronic temperature differential controller for up to four consumers with its own operator interface (6):
- Simple operation in accordance with Vitotronic control principles.
- High operating convenience through four-line menu-guided plain text display.
- For all conventional applications:
 - multi-cylinder use,
 - swimming pool water heating,
 - central heating backup.
- Large cable arrangement box for appropriate installation.

Solar-Divicon pump station

The Solar-Divicon (7) pump station for hydraulic functions and thermal protection. All necessary safety and function modules are combined in one compact assembly.

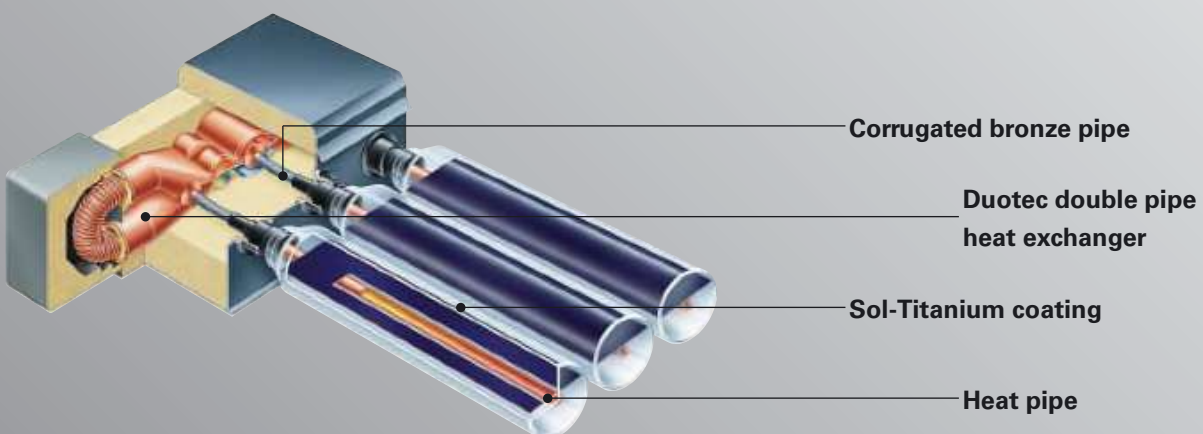
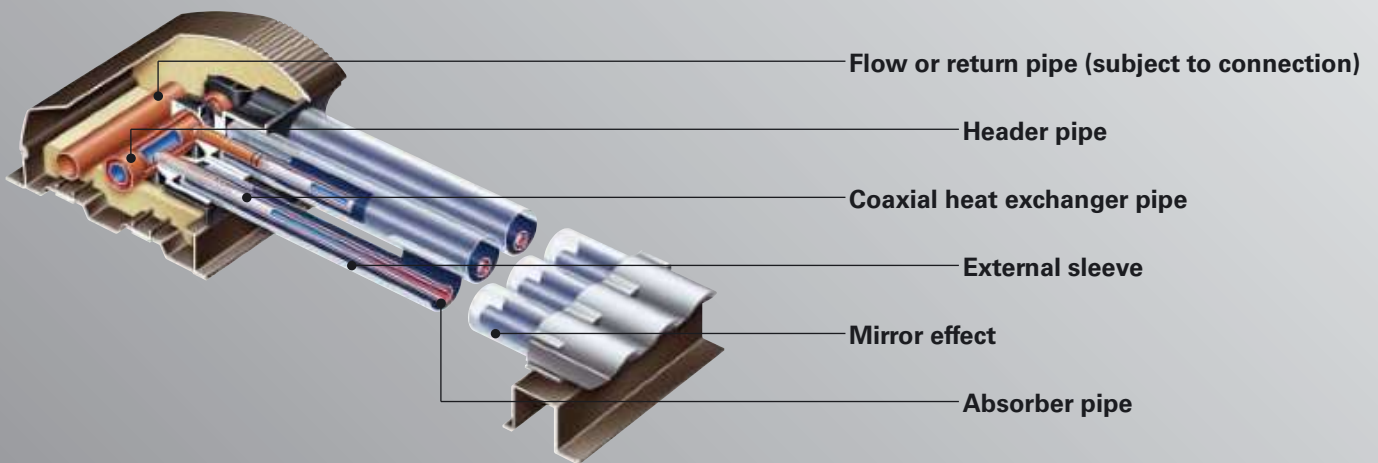
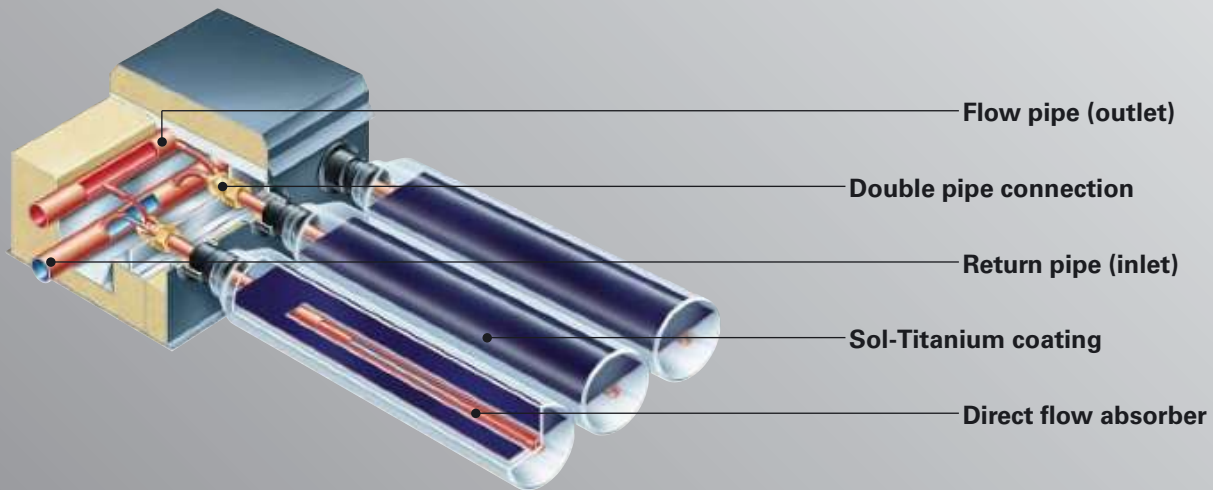
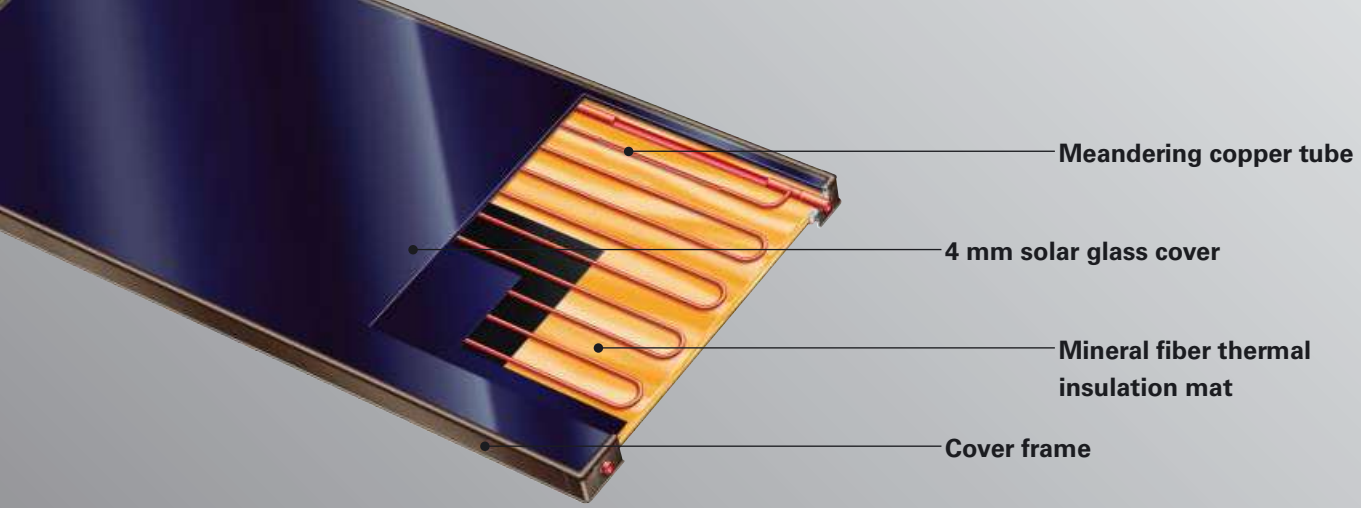

VITOSOL 100 Flat solar collector Sol-Titanium coating	Type		s 2.5	w 2.5	5DI
	Gross area	m ²	2.71	2.71	5.25
	Absorber area	m ²	2.50	2.50	4.76
	Aperture area	m ²	2.50	2.50	4.92
	Dimensions (overall)	Width mm	1138	2385	2570
		Height mm	2385	1138	2040
		Depth mm	102	102	116
Weight (incl. thermal insulation)	kg	60	60	105	

VITOSOL 200 Vacuum tube collector Direct flow Wall mounted Sol-Titanium coating	Version		D10	D20	D30
	Gross area	m ²	1.50	2.94	4.38
	Absorber area	m ²	1	2	3
	Aperture area	m ²	1.07	2.14	3.21
	Dimensions (overall)	Width mm	741	1450	2159
		Height mm	2028	2028	2028
		Depth mm	138	138	138
Weight (incl. thermal insulation)	kg	23	45	68	

VITOSOL 250 Vacuum tube collector Direct flow	Gross area	m ²		1.67
	Absorber area	m ²		1.43
	Aperture area	m ²		1.025
	Dimensions (overall)	Width mm		961
		Height mm		1735
		Depth mm		108
Weight (incl. thermal insulation)	kg		25	

VITOSOL 300 Vacuum tube collector Heat pipe principle Sol-Titanium coating	Type		H20	H30
	Gross area	m ²	2.94	4.38
	Absorber area	m ²	2	3
	Aperture area	m ²	2.14	3.21
	Dimensions (overall)	Width mm	1450	2159
		Height mm	2024	2024
		Depth mm	138	138
Weight (incl. thermal insulation)	kg	45	68	



Turn your home into a solar generator



Those who want to connect their household to the richest source of energy in the solar system, are best served by Viessmann solar heating systems. These combine ecology with economy to build a future-proof energy concept – important as energy resources decrease.

Future know-how

Naturally, apart from benchmark solar heating technology, we supply all necessary know-how to maximise its effective use. Your heating contractor will provide you with competent, expert advice. These contractors are, in turn, brought technically up-to-date through informative solar seminars run by the Viessmann Academy. For details about important grant systems (in Germany) see www.viessmann.com.

Benefits at a glance:

- Solar energy is environmentally responsible, protects natural resources and consistently reduces emissions.
- A solar heating system is an efficient and simple form of utilising solar energy. You save money as soon as the sun hits your roof.
- Environmentally-friendly energies are supported by many local and national governments.
- A solar heating system may increase the value of your property.
- Solar heating reduces your susceptibility to energy price rises.
- Modern solar heating technology on your roof is a visible sign of your commitment to the environment.



VIESSMANN

Vitotec: Technology Function Design

The Vitotec range successfully combines advanced, proven technology with the most recent innovative developments in the field. Modern technology, function and design are unified in Vitotec, and the human element is not forgotten either. All functions are clear and practical – for heating contractors, as well as system users.

Less means more

The Vitotec design is totally committed to this maxim. For that reason, everything about Vitotec has been reduced to essentials. The use of "Vitosilver" highlighted with "Vitorange" – the symbol for heat and warmth – visually unites Viessmann innovation with Viessmann tradition.

Platform strategy

The Vitotec range has been designed according to a well founded technical principle and is, as it claims, a completely unified system. With its Vitotec range, Viessmann presents heating equipment in a modular design based on platform strategy.

The basic chassis and function modules can be assembled into different equipment versions. Because of its modular design, this range has many identical components, it's uniform, installation steps are easily learned and there are only a few common spare parts. Installation, maintenance, service and operation are, as a consequence, substantially simplified.

Your heating contractor is a Viessmann expert

Vitotec offers even more – it includes a specialised service package for heating contractors. Courses run by the Viessmann Academy provide the opportunity for heating contractors to become conversant with the latest state of the art in heating equipment, and gain an insight into the future demands facing their industry. As a result, this means that your heating contractor is a Viessmann expert.

More than 30 coveted design awards for the Vitotec range, i.e.:



IF Product Design Award



Observer du Design 2001



Design Plus – Sanitär, Heizung, Klima



Bundespreis Produkt-design



Design Innovation, Design Zentrum NRW



Internationaler Designpreis Baden-Württemberg



reddot award product design

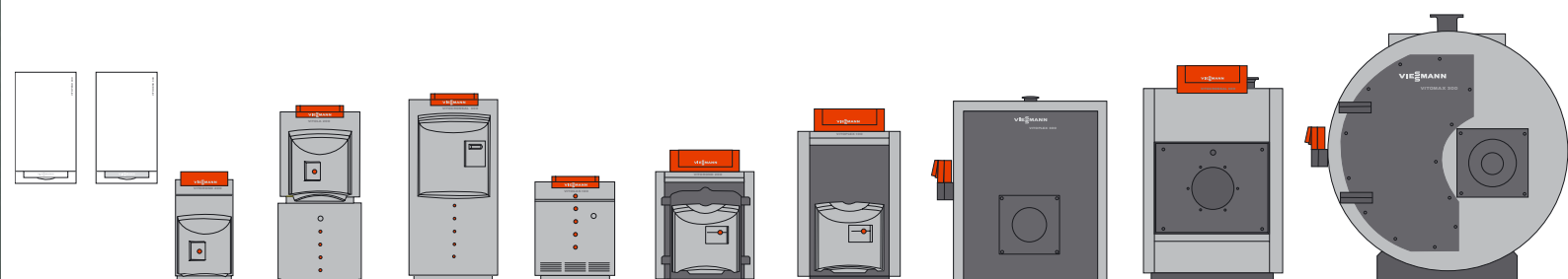



The Viessmann Group

The Viessmann Group employs approximately 6800 staff worldwide and is one of the foremost manufacturers of heating equipment. For freestanding boilers, Viessmann is the most successful brand in Europe. The Viessmann brand stands for competence and innovation. The Viessmann Group offers a comprehensive range of top-quality, high-tech products along with perfectly matched modular components. For all their diversity, our products have one thing in common: a consistently high standard of quality that is reflected in operational reliability, energy savings, environmental compatibility and user-friendliness.

Many of our developments point the way forward for the heating sector, both in terms of conventional heating technologies and in the field of renewable forms of energy, such as solar and heat pump technology.

In all our developments we pursue our philosophy of always achieving the greatest possible benefit: for our customers, the environment and our partners, the heating contractors.

The Viessmann Group:
Viessmann Werke
 D-35107 Allendorf (Eder)
 Tel: +49 6452 70-0
 Fax: +49 6452 70-2780
www.viessmann.com

Viessmann UK Office:
Viessmann Limited
 Hortonwood 30, Telford
 Shropshire, TF1 7YP, GB
 Tel: +44 1952 675000
 Fax: +44 1952 675040
 E-Mail: info-uk@viessmann.com



Viessmann offers you a diverse range of products, which are uniform in quality and adaptable enough to be able to meet any demand and any requirement



Wall mounted oil and gas fired condensing boilers



Your local heating contractor:

VIESSMANN